

SHAD

SOFT BAGS

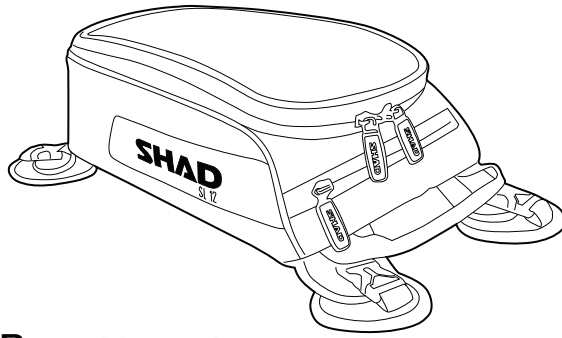

X0SL12 Small Tank Bag - Magnetic

	Magnetic	1
	Shoulder strap	2
	Outlet for USB Charger	3
	Inner pockets	4
	Mobile Phone Holder	5
	Touch screen	6

COMPONENTS

(A) MAGNETS X4 UND

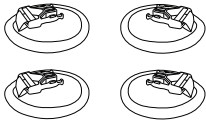

(B) SHOULDER STRAP X1 UND

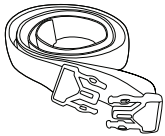

(C) SECURITY STRAP X1 UND

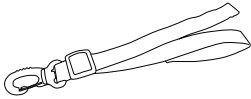

FEATURES

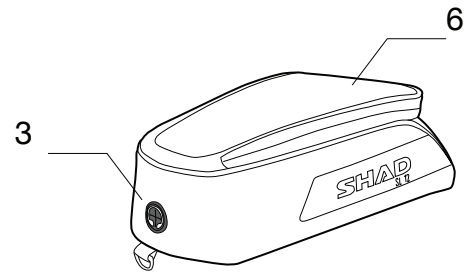
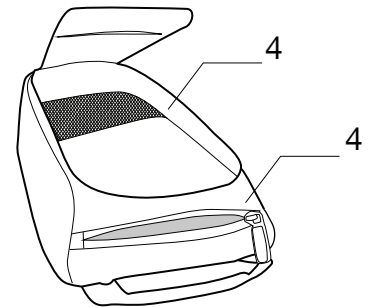
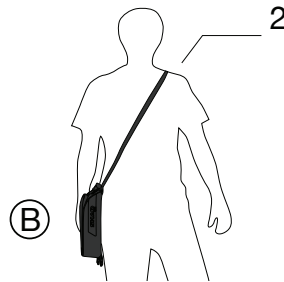
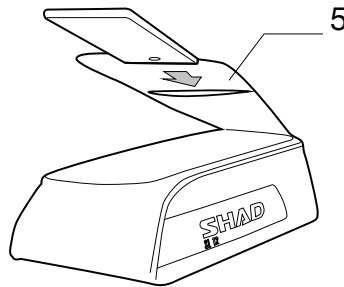

⚠ WARNING

Clean the tank of the bike before placing the magnets (or the optional base) to avoid scratches in the paint.

Make sure the bag and its accessories are properly assembled. Always use the safety belt.

To clean the bag use a damp cloth with neutral soap. Never use solvents or chemical products.

Prolonged exposure to the elements might discolor fabrics and wear away plastic components.

Waterproof zippers and rain covers do not guarantee that the bag is totally waterproof.

Use zippers with care. To open the bags slide zip all the way without forcing.

Maximum load: 1,5 Kg.

Maximum speed: 120 km/h or 74 mph.

SHAD will not hold responsibility for damages caused by an incorrect assembly.

⚠ PRECAUCIÓN

Limpiar el depósito de la moto antes de posicionar los imanes (o base universal opcional) para evitar rayadas en la pintura.

Asegurarse que la bolsa y todos sus accesorios están correctamente montados. Siempre hacer uso de la correa de seguridad.

Si requiere limpiar las bolsas utilice un paño húmedo con jabón neutro, nunca utilice disolventes o productos químicos.

La exposición prolongada a la intemperie puede ocasionar cambios en el color de tejidos y desgaste de componentes plásticos.

Los forros de lluvia no garantizan completa impermeabilidad de la bolsa.

Utilizar las cremalleras con cuidado, para abrir, deslizarlas hasta el final sin forzarlas.

Capacidad de carga: 1,5 Kg. máximo.

La velocidad de la moto con una bolsa tiene que ser de máximo 120 km/h o 74 mph.

SHAD no se hará responsable de los daños causados por un incorrecto montaje.

⚠ ATTENTION

Nettoyez le réservoir de la moto avant de placer les aimants (ou base universelle optionnel) pour empêcher de rayer la peinture.

Assurez-vous que le sac et tous ses accessoires sont montés correctement. Utilisez toujours la ceinture de sécurité.

Si vous avez besoin de nettoyer le sac, passez un drap humide avec un savon neutre. N'utilisez pas de dissolvants ou de produits chimiques.

Une exposition prolongée à l'air libre peut provoquer des changements dans la couleur du tissu et l'usure des composants en plastique.

La housse de pluie n'assure pas l'imperméabilité complète du sac.

Utilisez les fermetures doucement pour ouvrir, faites-les glisser jusqu'au fin sans forcer.

Capacité: 1,5 kg au maximum.

La vitesse de la moto avec un sac devrait être d'un maximum de 120 km/h ou 74 mph

SHAD ne sera pas responsable des dommages causés par un montage incorrect.

MOTO FIXATION

Magnetic

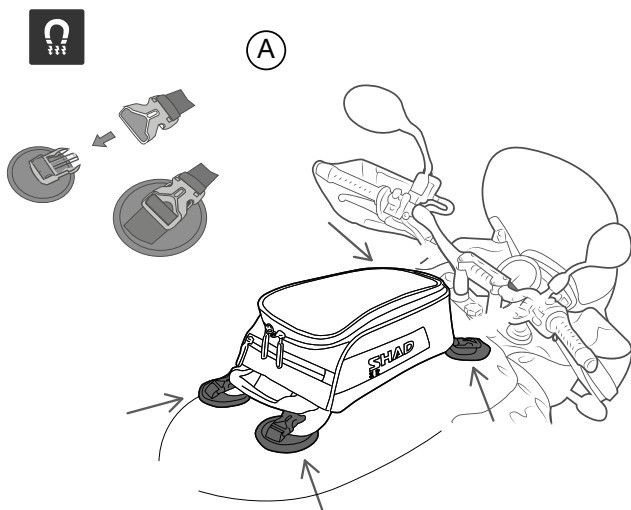

Security Strap

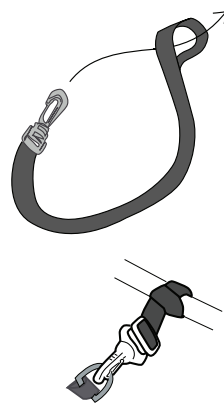

C

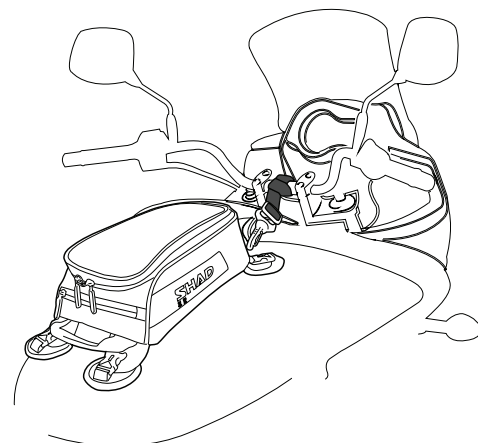

ACCESSORIES NOT INCLUDED - SOLD SEPARATELY

USB Universal
Moto Charger
Ref: X1SB95

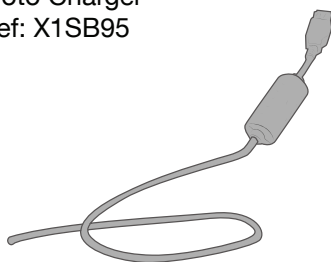

Rain Cover
Ref: X1SL01

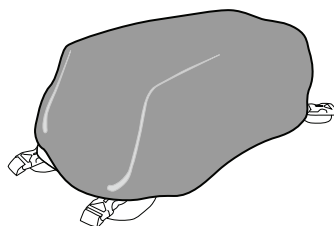

Universal Base Tank
Ref: X1SL90

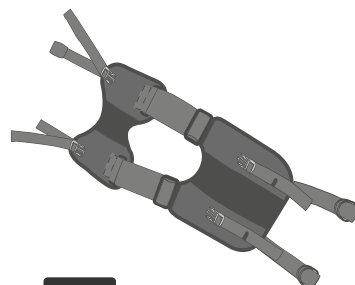

SHAD

MORE SOFT BAGS FROM SHAD



SL20
Tank Bag (Straps Fastener)
Ref. X0SL20F



SL58
Big Saddle Bag
Ref. X0SL58



SL05
Big Rider Leg Bag
Ref. X0SL05